

Carbon fiber street bike helmets,best carbon fiber helmet SV888



The description of carbon fiber racing helmets:

In-mould Carbon Construction: The In-mould construction is a technique that directly fuses the shock absorbing EPS liner with the Polycarbonate shells and carbon piece to create a light weight and strong structure. The carbon fiber reinforcement adds additional strength in critical areas due to its great strength and impact distribution properties.

- Well-ventilated, with very cooling air tunnel and reasonable aero shape design.
- Three-dimensional duct design: This design is very aerodynamic drag coefficient is small , in the process

of riding , people wear more cool.

- In-mold technology, when the helmet by the impact , the entire helmet uniform force.
- The high quality eco-friendly high temperature resistant PC shell.
- The high density black EPS material is imported from American,
- The bicycle accessories: adjustable chin strap with quick-release buckle; rear lock adjustment; cool insect-proof not comfortable pads;
- Certification: CE-EN1078 certified for impact protection.

The specification of carbon fiber racing helmets:

Model No.	AU-SV888
Material	EPS (Expanded Polystyrene) + PC (Polycarbonate) Shell + Carbon Fiber Enforcement Piece Bridge
Certification	CE EN1078
Vents	30 air vents
Color	Pantone, customized
size/head circumference	S/M (54-58CM) M/L (58-62CM)
Weight	240g
Sample Time	7 days
MOQ	300pcs
Package details	PP bag+individual color box packing+mastercarton

The detail pictures of carbon fiber racing helmets:













The Customized accessories:

There are four different helmet strap buckle for your freely choice:

- Standard ITW brand Nylon helmet buckle
- Traditional helmet buckle
- Patent self-developed magnetic buckle (the comprehensive safety, functionality and great ease of use of helmets with the "one-hand fastener", with strong magnets make them easy to close and open, very convenient and safe).
- Fidlock brand magnetic buckle.

Customized varieties colors of helmet accessories for your freely choice:

- Available helmet lockable strap divider in varieties color.
- Available helmet strap buckle in varieties colors.
- Available helmet strap holder in varieties colors.

Buckle Options



B001



ITW standard helmet buckle



Traditional helmet buckle



B002



Patent self-developed magnetic buckle



Fidlock magnetic buckle



B003



We can also customize various colors buckle.

Female Parts Options To Anchor Strap



M001



M002



M003



M004



M005

Strap Buckle And Divider Options

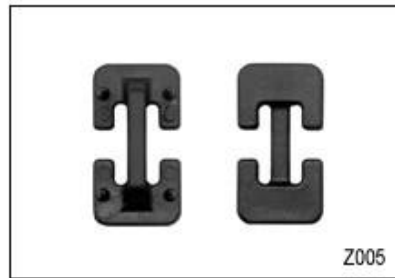

We can also customize various colors buckle.



Don't be surprised! As a factory with 23-year R&D experience, we have developed a serie of adjustments for different helmets & comply with different helmet designs! You can find Up & Down adjuster, Y shape adjuster, LED adjuster, full head adjuster, transparent adjuster, integrated adjuster, etc. all at our factory! What's more, in order to satisfy your brand demand, we can add logo stickers or customize your exclusive adjuster according to your design or idea! The multi-color combination of our adjustments is also one of its highlights. We promise every rotating dial adjustment is of well-made & can provide you a comfortable & stable fitting experience!

Adjustment System Options

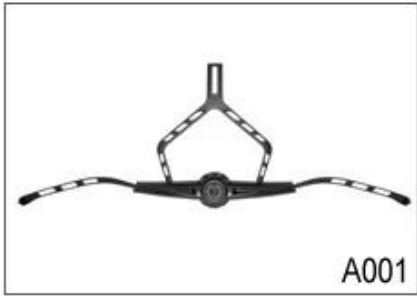

A001

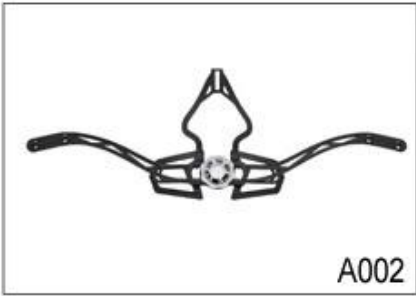

A002



A003

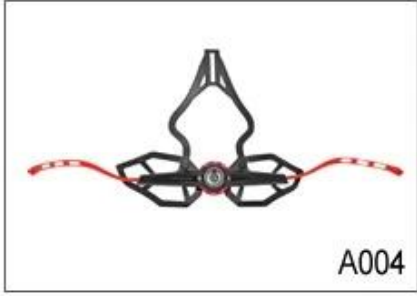

A004



A005

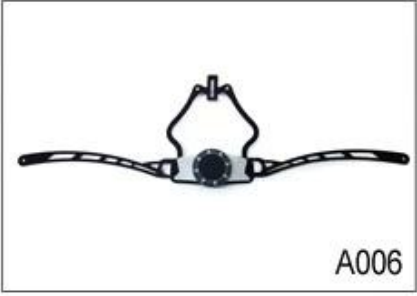

A006

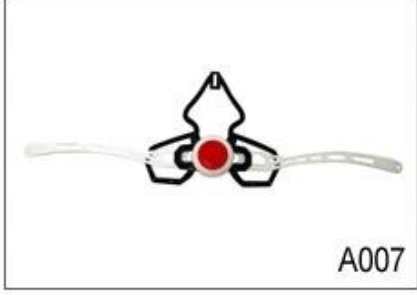

A007

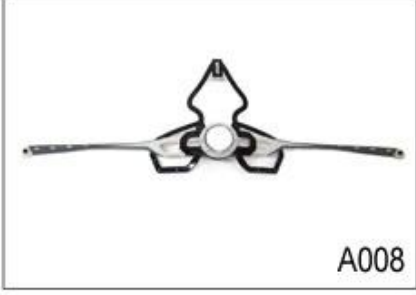

A008



A009



A010



A011

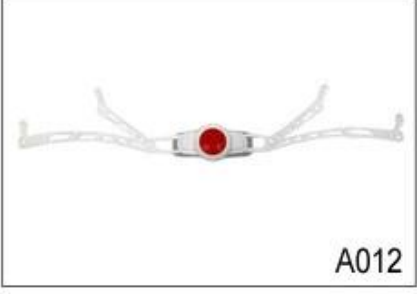

A012

Female Parts Options To Anchor Adjuster

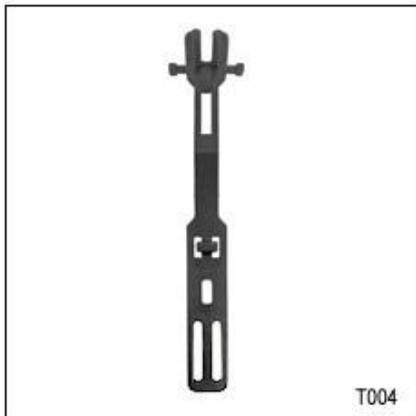

There different kinds of inner padding fabric options.

EVA pads: It is closed cell and impervious to water, has resilient feel.

Mesh pads: it can prevent dust and small insect fly into the helmet during wild riding.

Nylon pads: antibacterial and skin-friendly, easy to clean.

Velvet pads: very soft and comfortable feeling.

Cool max pads: very high-end, can keep the hair dry and cool during riding.

Low quality pads: easy broken after friction with hair, uncomfortable and hot.

Inner Padding Fabric Options



EVA pads



Mesh pads

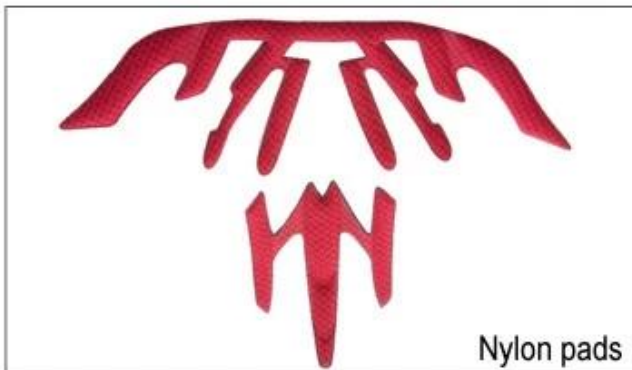

Nylon pads



Velvet pads



Cool max pads



Low quality pads

There are different kinds of inner pads for your choice.

first is 3D open mesh padding, it have to be opened a hot-press mold; second is cool max padding, we need to buy pad from cool max company with MOQ 1000 yards, third is ANTI-INSECT net, which could prevent small bug from going into your helmet at dusk, forth one is featherweight gel inserts, cheap and low quality pads

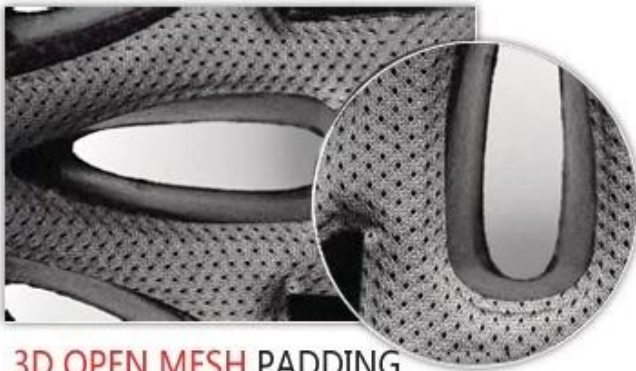

3D OPEN MESH PADDING



COOL MAX® PADDING



ANTI-INSECT NET



FEATHERWEIGHT GEL INSERTS

The head circumference knowledge of carbon fiber racing helmets:

European Headform:

An Oval shaped helmet is designed for a rider's head with a dimension which is considerably fit for Europeans.

Generic headform:

A generic headform helmet is designed for a rider's head with a dimension which is slightly longer front-to-back than its side-to-side measurement.

Asian headform:

A Round shaped helmet is designed for a rider's head with a dimension which is condierably fit for Asians.

Helmet Shape 101



European Headform

An Oval shaped helmet is designed for a rider's head with a dimension which is considerably fit for Europeans.

Generic headform

A generic headform helmet is designed for a rider's head with a dimension which is slightly longer front-to-back than its side-to-side measurement.

Asian headform

A Round shaped helmet is designed for a rider's head with a dimension which is considerably fit for Asians.

Our Test lab:

In order to manufacture quality helmets, we learn not only from the design theory, but also make progress from testing result! That's why our factory equipped with professional testing lab to ensure every design is practical & amenable! Our testing standard is more strict than the related certificate requirements, that's why we can promise the model that we provide can definitely pass the corresponding test by third-party!

Our In-house Testing Lab



Certification:

Below is our certificate :we have ISO9001 ,letters patent ,CE documents ,and we have our own lab to make sure every our product can meet the testing requirements

CERTIFICATE



Facility Show:

1. Carbon Fiber Helmet made by Extrusion blow molding process

Carbon fiber helmet mold in vacuum forming



2. Autoclave Processing (Vacuum bagged)

Autoclave Processing (Vacuum bagged)



Raw Material Show:



UD Tow



12k Tow

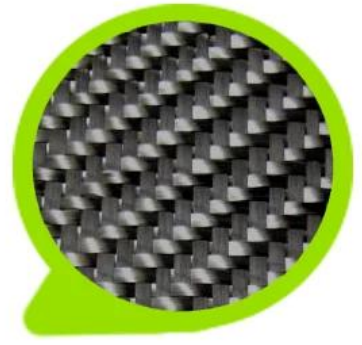

3k Tow



1k Tow



Spread Tow

The delivery express:

International express, air freight & sea transportation are all can be well arranged here! You can pick every possible transportation that you want & we will do our best to assist you! We have already built a long-term relationship with different shipping companies & shipping agent, all our efforts aim at providing you the best shipping experience! Choose us, it will be easy to keep the helmets safe all the time!

PAYMENT

- We accept T/T ,Western Union or Paypal before production
- If buyers have any problems about payment , please contact us ASAP



SHIPPING

- 3-15 working days since payment receipt (based on actual quantity)
- Tracking No. will be sent to you after delivery . And you will get every important shipping status by email.

