

CE AU-BH20



Product Details

| | |
|------------|----------------|
| Model | CE AU-BH20 |
| SKU | au-bh20 |
| Material | PC+EPS + |
| Size | S / M |
| Weight | |
| Dimensions | 73 * 58 * 35cm |
| Quantity | 12pcs / ctn |
| Incoterms | fob / cfr |
| Payment | TT / PayPal |
| Lead Time | 3-10days |
| Delivery | 10-40days. |

| | |
|----------|------------------------------------|
| fearear | 00000000/00000000/0000000000000000 |
| 00000000 | 0000 |

00/0000000000000000000000000











安全規格

符合EN1078標準4點式安全帶

- 符合ITW認證
 - 符合EN1078標準
 - 符合EN1078標準4點式安全帶
- 符合EN1078標準4點式安全帶
- 符合EN1078標準

符合EN1078標準4點式安全帶

- 符合EN1078標準
- 符合EN1078標準

Buckle Options



B001



ITW standard helmet buckle



Traditional helmet buckle



B002



Patent self-developed magnetic buckle



Fidlock magnetic buckle



B003



We can also customize various colors buckle.

Female Parts Options To Anchor Strap



M001



M002



M003



M004



M005

Adjustment System Options

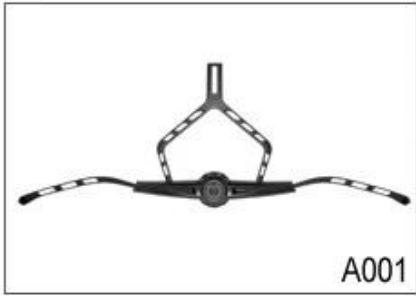

A001

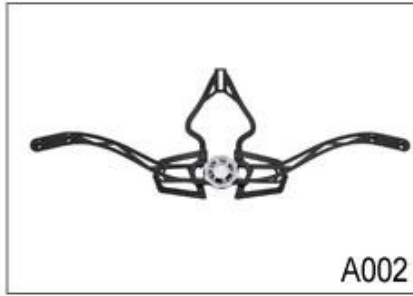

A002

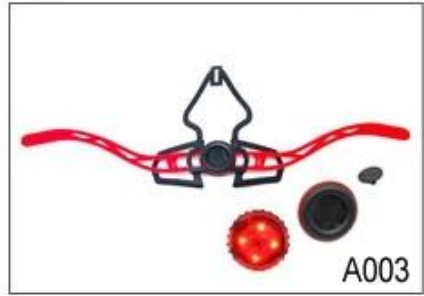

A003

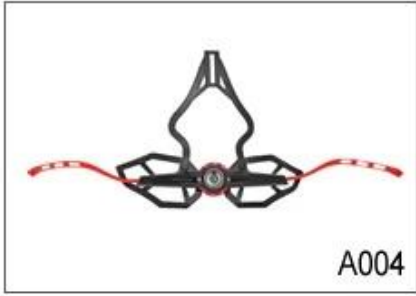

A004



A005

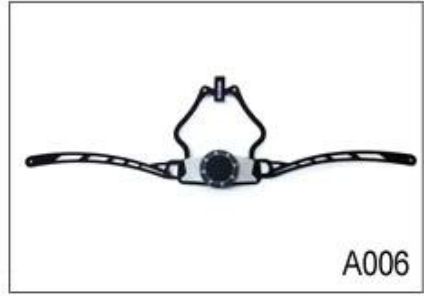

A006

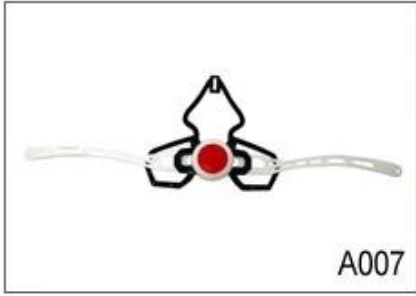

A007

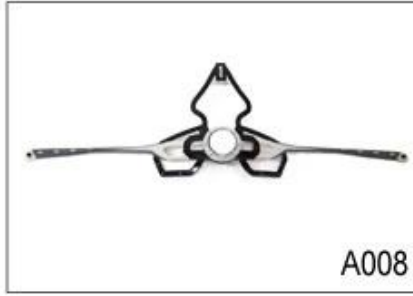

A008



A009



A010



A011

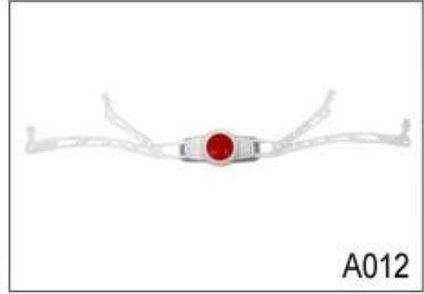

A012

Female Parts Options To Anchor Adjuster



T001



T002



T003

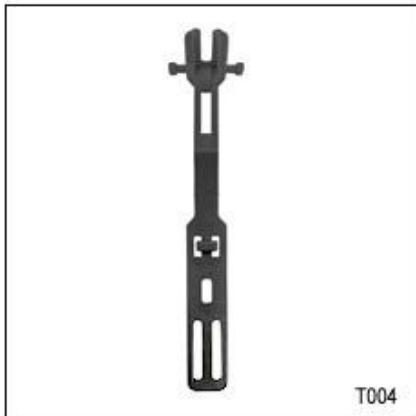

T004



T005



T006

1. 此類零件均為可選配零件，請根據實際需求進行選擇。
 EVA 泡棉墊片，用於增加舒適性。
 2. 此類零件均為可選配零件，請根據實際需求進行選擇。
 3. 此類零件均為可選配零件，請根據實際需求進行選擇。
 4. 此類零件均為可選配零件，請根據實際需求進行選擇。
 5. 此類零件均為可選配零件，請根據實際需求進行選擇。
 6. 此類零件均為可選配零件，請根據實際需求進行選擇。
 7. 此類零件均為可選配零件，請根據實際需求進行選擇。

